

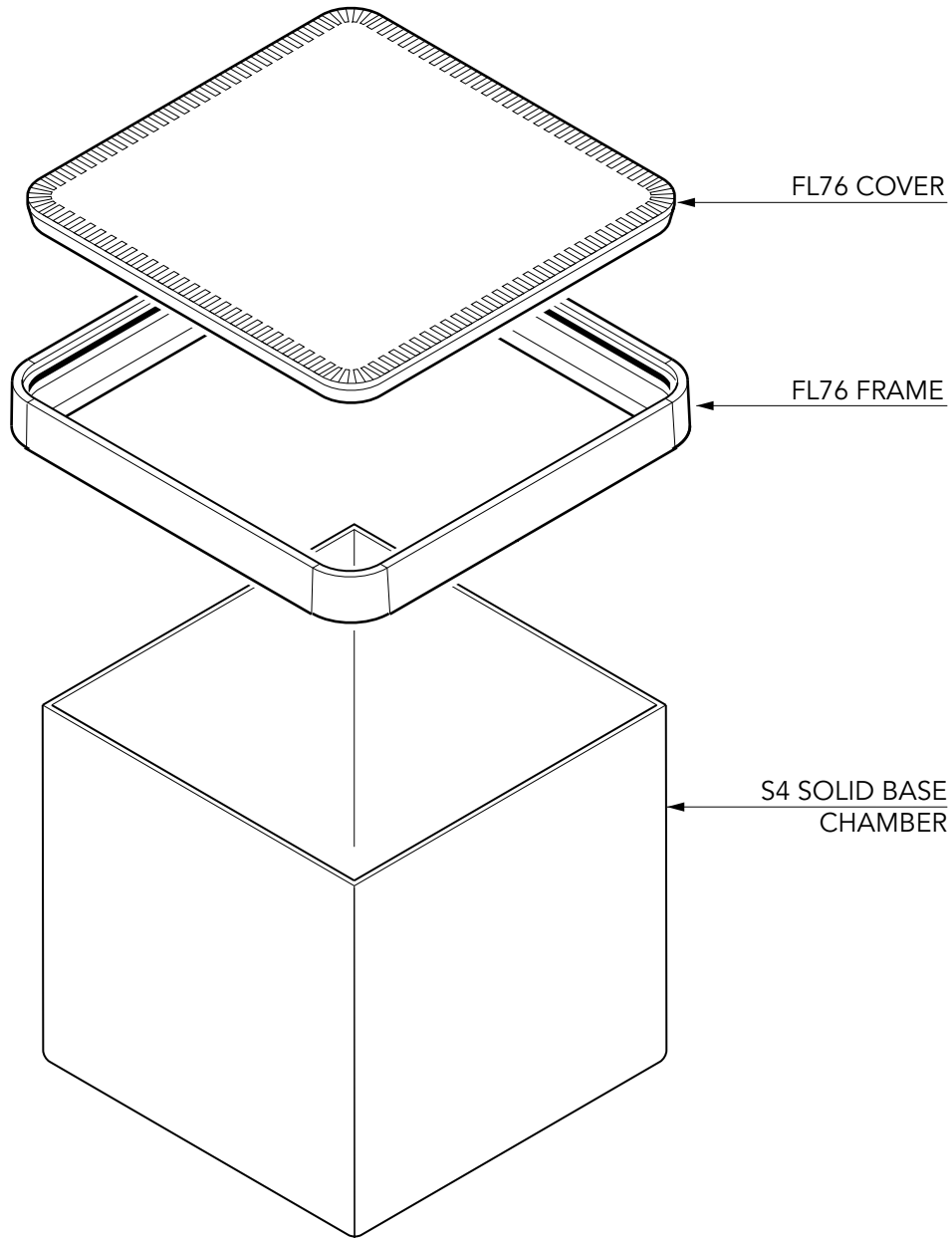

<b>Notes:</b>	Category: <b>DIRECT TO FRAME SQUARE CHAMBER SYSTEMS</b>		 <b>FIBRELITE</b>
	Product Description: 760mm square x 760mm deep solid base chamber with a square 760mm flat sealed cover.		
For reference puposes only. This drawing is not a specification.	Drawing No.: <b>1</b>	Product Code: <b>S4-376</b>	
	Date: <b>Sept 2008</b>	Revisions:	



<b>Notes:</b>	Category: <b>DIRECT TO FRAME SQUARE CHAMBER SYSTEMS</b>		 <b>FIBRELITE</b>
	Product Description: 760mm square x 760mm deep solid base chamber with a square 760mm flat sealed cover.		
For reference puposes only. This drawing is not a specification.	Drawing No.: <b>2</b>	Product Code: <b>S4-376</b>	
	Date: <b>Sept 2008</b>	Revisions:	



**VERY IMPORTANT**  
 OUTER EDGE "A" OF FRAME SET 5 - 10MM  
 ABOVE GENERAL FORECOURT AREA WITH  
 CONCRETE RAMPED AWAY OVER 300MM.

TYPICAL INSTALLATION

CONCRETE

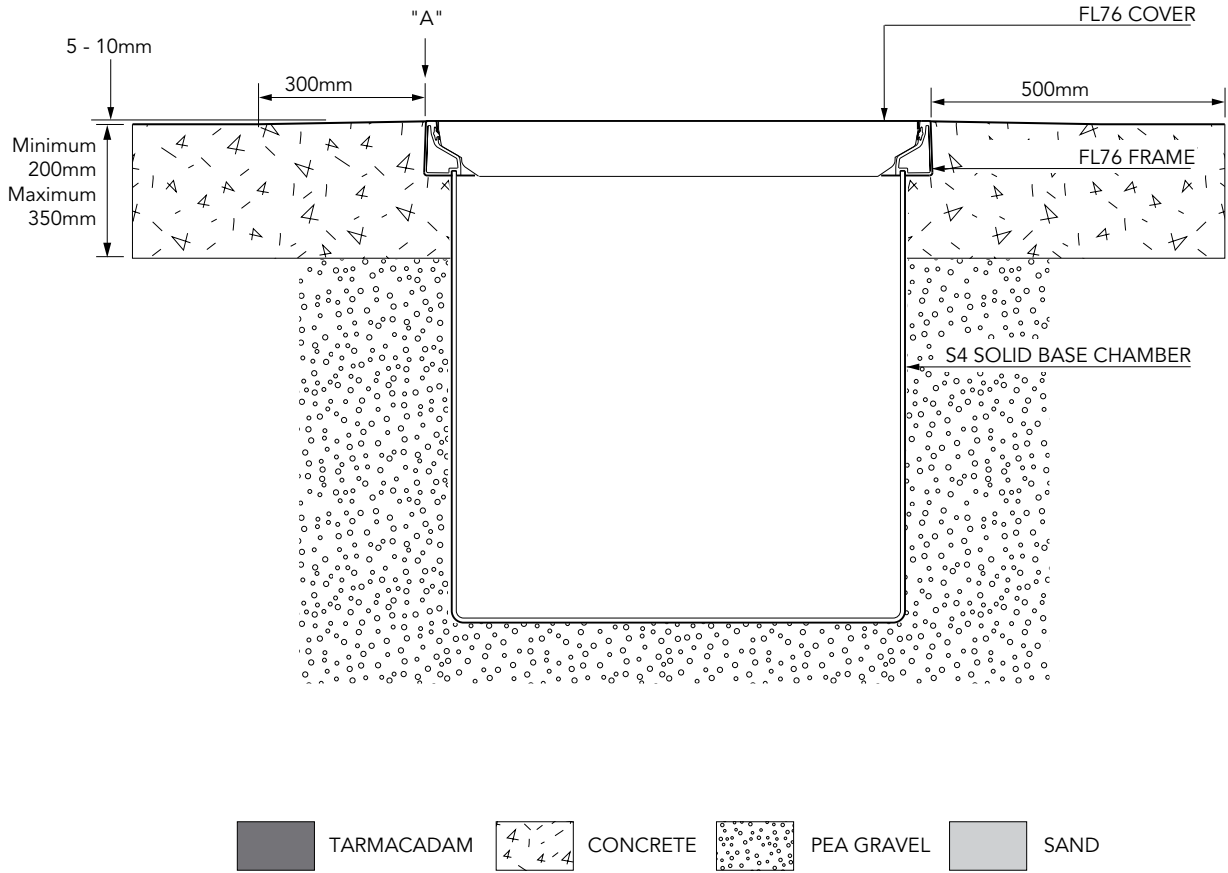

ALTERNATIVE INSTALLATION ADVICE

TARMACADAM

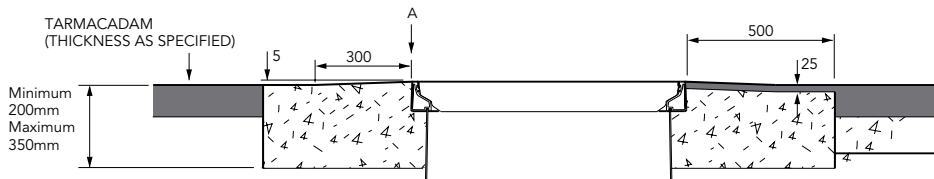

SETTS

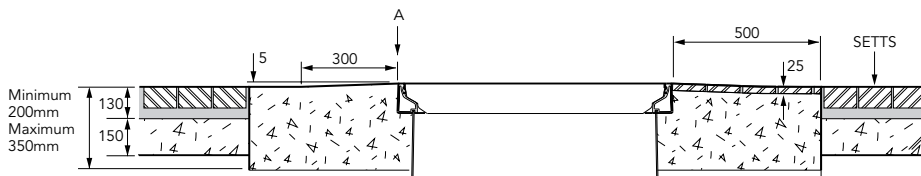

<b>Notes:</b>	Category: <b>DIRECT TO FRAME SQUARE CHAMBER SYSTEMS</b>	
	Product Description: <b>760mm square x 760mm deep solid base chamber with a square 760mm flat sealed cover.</b>	
For reference purposes only. This drawing is not a specification.	Drawing No.: <b>3</b>	Product Code: <b>S4-376</b>
	Date: <b>Sept 2008</b>	Revisions:

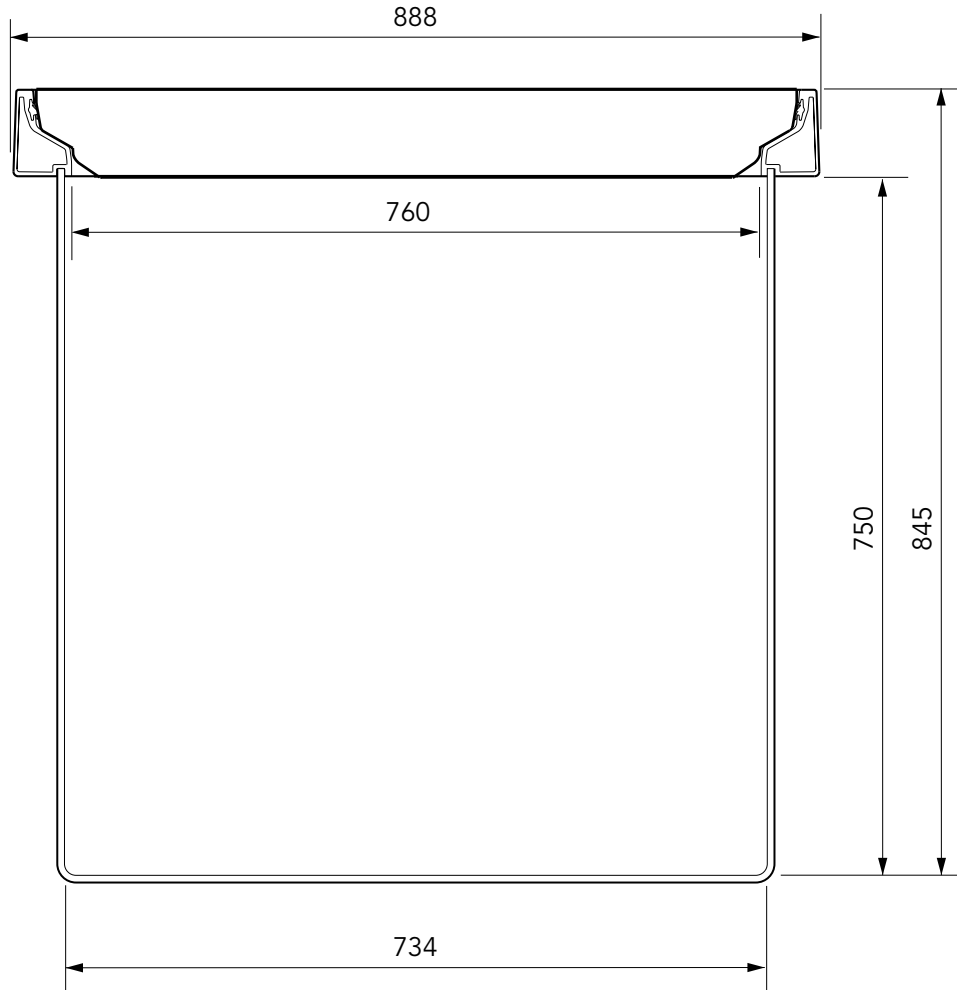

<b>Notes:</b>	Category: <b>DIRECT TO FRAME SQUARE CHAMBER SYSTEMS</b>		 <b>FIBRELITE</b>
	Product Description: 760mm square x 760mm deep solid base chamber with a square 760mm flat sealed cover.		
For reference puposes only. This drawing is not a specification.	Drawing No.: <b>4</b>	Product Code: <b>S4-376</b>	
	Date: <b>Sept 2008</b>	Revisions:	